

December 17, 2014

The Board of Commissioners of Public Utilities
Prince Charles Building
120 Torbay Road, P.O. Box 21040
St. John's, Newfoundland & Labrador
A1A 5B2

Attention: Ms. Cheryl Blundon
Director Corporate Services & Board Secretary

Dear Ms. Blundon:

**Re: Newfoundland and Labrador Hydro - the Board's Investigation and Hearing into
Supply Issues and Power Outages on the Island Interconnected System: Supplementary
Response in Relation to PUB-NLH-457 and PUB-NLH-458**

In its responses to the Board's RFIs PUB-NLH-457 and PUB-NLH-458, Hydro indicated that additional documentation would be supplied to the Board when the related work was completed. In this regard, please find enclosed the original and 12 copies of the following:

- a) Hydro's analysis of the impact of transmission line contingencies on system losses related to alternate generation dispatches (re: PUB-NLH-457); and,
- b) Two reports by Trans Grid Solutions Inc. related to the simulation of the Sunnyside T1 failure and an investigation of the Western Avalon T5 transformer failure concerning whether or not harmonics or system resonance were contributing factors to the system events of January, 2014 (re: PUB-NLH-458).

We trust the foregoing is satisfactory. If you have any questions or comments, please contact the undersigned.

Yours truly,

NEWFOUNDLAND AND LABRADOR HYDRO

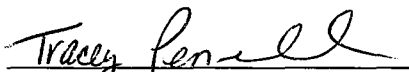

Tracey L. Pennell
Legal Counsel

TLP/jc

cc: Gerard Hayes – Newfoundland Power
Paul Coxworthy – Stewart McKelvey Stirling Scales
ecc: Roberta Frampton Benefiel – Grand Riverkeeper Labrador

Thomas Johnson – Consumer Advocate
Danny Dumaresque

Engineering Support Services for:

Sunnyside Transformer T1 Fire

Newfoundland and Labrador Hydro

Attention:

Mr. Peter Thomas

Report R1335.01.00

PSCAD Investigation of the Sunnyside T1 Transformer Failure

Prepared by:

TransGrid Solutions Inc.

200 – 150 Innovation Dr.

Winnipeg, MB R3T 2E1

CANADA

www.transgridsolutions.com

Oct 5th, 2014

Disclaimer

This report was prepared by TransGrid Solutions Inc. ("TGS"), whose responsibility is limited to the scope of work as shown herein. TGS disclaims responsibility for the work of others incorporated or referenced herein. This report has been prepared exclusively for Newfoundland and Labrador Hydro and the project identified herein and must not be reused or modified without the prior written authorization of TGS.

Revisions

| | |
|-------------------|---|
| Project Name: | Sunnyside Transformer T1 Fire |
| Document Title: | PSCAD Investigation of the Sunnyside T1 Transformer Failure |
| Document Type: | Draft report |
| Document No.: | R1335.01.00 |
| Last Action Date: | Oct 5th, 2014 |

| Rev. No. | Status | Prepared By | Checked By | Date | Comments |
|----------|--------|-------------|------------|----------|----------|
| 00 | IFC | D. Kell | R. Kolt | 05/10/14 | |
| 01 | | | | | |
| | | | | | |
| | | | | | |
| | | | | | |

Legend of Document Status:

| | |
|-------------------------|-----|
| Approved by Client | ABC |
| Draft for Comments | DFC |
| Issued for Comments | IFC |
| Issued for Approval | IFA |
| Issued for Information | IFI |
| Returned for Correction | RFC |
| Approval not Required | ANR |

Table of Contents

| | |
|---|-----------|
| 1. Introduction | 3 |
| 2. PSCAD Model Development..... | 5 |
| 2.1 AC System model | 5 |
| 2.2 AC Transmission Lines | 7 |
| 2.3 Power Transformers..... | 9 |
| 2.4 T5 Transformer at Sunny Side and T1 Transformer at Western Avalon | 10 |
| 2.5 PSCAD Model Benchmarking Against PSS/E..... | 12 |
| 3. Modeling of Fault..... | 14 |
| 3.1 Transformer Fault | 14 |
| 4. Results..... | 15 |
| 5. Conclusions and Recommendations | 19 |

List of Figures

| | |
|--|----|
| Figure 1-1 Example of Low resolution waveforms | 3 |
| Figure 2-1 SLD of Newfoundland System | 6 |
| Figure 2-2 Example Line Layout | 8 |
| Figure 2-3 Detailed Line Model | 9 |
| Figure 2-4 T1 - SSD T5 - WAV | 10 |
| Figure 2-5 Sunny Side T1 transformer model | 11 |
| Figure 2-6 SSD T1 Parameters | 12 |
| Figure 4-1 PSCAD Simulation | 15 |
| Figure 4-2 Actual Event..... | 15 |
| Figure 4-3 Transformer Currents | 16 |
| Figure 4-4 Harmonics of Transformer (RMS)..... | 17 |
| Figure 4-5 Bay D'Espoir and TL237 measurements | 18 |

List of Tables

| | |
|---|----|
| Table 2-1 Frequency Dependent AC lines..... | 7 |
| Table 2-2 SSD T5 - WAV | 10 |
| Table 2-3 SCL Comparison | 12 |
| Table 2-4 Positive Sequence Impedance Comparison..... | 13 |
| Table 2-5 Loadflow Comparison | 13 |
| Table 3-1 AC system Fault Sequence | 14 |
| Table 3-2 Internal Transformer Fault Sequence | 14 |

1. Introduction

This report presents the findings of the PSCAD simulation trying to recreate the Newfoundland T1 transformer fault that occurred at 9:05am on January 4th, 2014.

The original scope of the project was to model the fault based on delivered comtrade data which records the pertinent waveforms. Upon receipt of the data, the following was noticed:

1. The comtrade data delivered for times:
04/01/2014,13:13:09.000260
04/01/2014,10:05:34.000260

Both of which did not match the time of the fault. The comtrade data which had the same time stamp as the fault was delivered as a pdf file, which is included in Appendix A.

2. The comtrade data had a very low resolution as shown in Figure 1-1, which made it very hard to match to the PSCAD simulation.

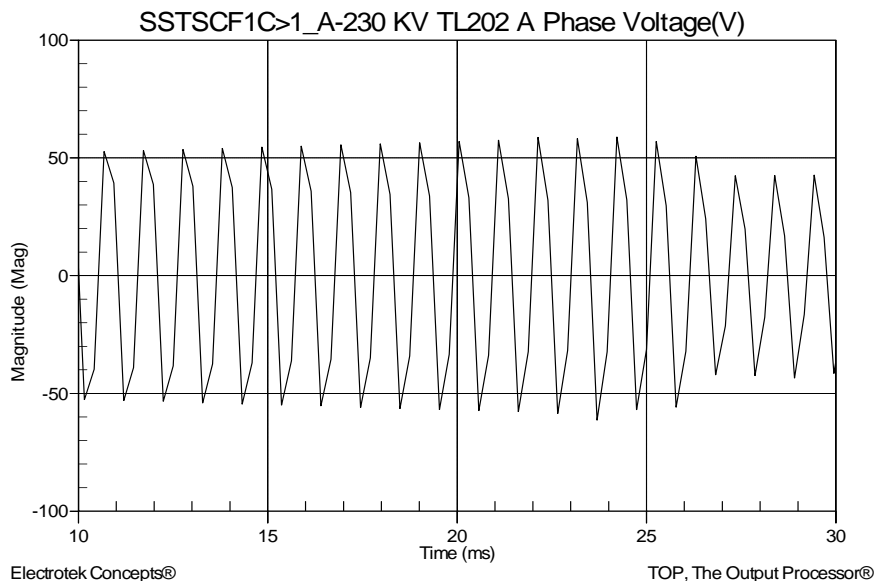

Figure 1-1 Example of Low resolution Waveforms

APSCAD model was created on the following information in order to try and recreate the fault based on the pdf comtrade file.

- 2014Base-Peak for Dyr.sav
- PSS/E data file which represents the Newfoundland System conditions prior to the fault
- Peak Case.dyr
- PSS/E dynamics file
- SSDTS T1 transformer nameplate, test data and transformer data (delivered as pdf files)
- WAVTS T5 transformer nameplate, test data and transformer data (delivered as pdf files)

- AC Line geometric data based on past work performed by TGS. This included mutual coupling of the lines the shared the same right-of-way.
- AMEC report “Newfoundland and Labrador Hydro Transmission Availability” March 21, 2014. This report gave the details of the sequence of events during the fault on January 4th.

2. PSCAD Model Development

2.1 AC System model

The following files provided by Newfoundland and Labrador Hydro (NLH) and were used as the base case to develop the equivalent PSCAD model:

- 2014Base-Peak for Dyr.sav
- Peak Case. Dyr

The equivalent ac system in PSSE was converted to PSCAD. Since this study deals with a transient phenomenon as a result of transformer failure at Sunnyside, the representation of the power system components with more accuracy at higher frequencies than the fundamental frequency is crucial for a better analysis of the event. Therefore the following changes were made to the converted case:

- All the generators were represented with their associated dynamic data. That includes also exciter, governor and power system stabilizers models (PSS)
- A majority of the transmission lines surrounding the Sunnyside and Western Avalon were modeled with frequency dependent line models according to the tower geometries and conductor configurations
- T1 transformer at Sunnyside and T5 transformer at Western Avalon based on the latest data provided by NLH

Figure 2-1 shows the single line diagram of the ac system used in this study. Please note that the whole case is not shown in the diagram and only the main portion of the ac system surrounding Sunnyside and Western Avalon is shown.

2.2 AC Transmission Lines

The major transmission line models in the PSCAD case which when originally converted from PSS/E, were represented as pi-sections and Bergeron line models

The Bergeron and pi-section line representations are only adequate for studies that essentially require the correct fundamental frequency impedance. However, in order to get a higher degree of accuracy, some of the lines near the affected buses were replaced with frequency dependent line models.

Table 2-1 lists of the lines that were modeled as frequency dependent lines.

Table 2-1 Frequency Dependent AC lines

| From Bus# | To Bus# | From Bus# | To Bus# |
|-----------|---------|-----------|---------|
| 195229 | 195230 | 195167 | 195169 |
| 195222 | 195227 | 195169 | 195171 |
| 195221 | 195216 | 195171 | 195173 |
| 195216 | 195215 | 195173 | 195175 |
| 195221 | 195220 | 195222 | 195229 |
| 195220 | 195218 | 195227 | 195229 |
| 195215 | 195208 | 195229 | 195236 |
| 195215 | 195205 | 195229 | 195234 |
| 195205 | 195536 | 195234 | 195236 |
| 195205 | 195208 | 195236 | 195238 |
| 195622 | 195625 | 195221 | 195222 |
| 195625 | 195627 | 195152 | 195153 |
| 195124 | 195122 | 195153 | 195154 |
| 195122 | 195120 | 195155 | 195157 |
| 195120 | 195115 | 195157 | 195159 |
| 195115 | 195112 | 195152 | 195159 |
| 195112 | 195111 | 195620 | 195620 |
| 195209 | 195210 | 195621 | 195622 |
| 195208 | 195209 | 195112 | 195113 |
| 195205 | 195206 | 195600 | 196500 |
| 195500 | 195620 | - | - |

Figure 2-2 shows an example of one of the more complicated line layouts, which includes the mutual coupling of lines TL201, TL242 and TL218 and the mutual coupling of lines TL201 and TL217. Figure 2-3 shows the detailed line model for the lines TL201, TL242 and TL218.

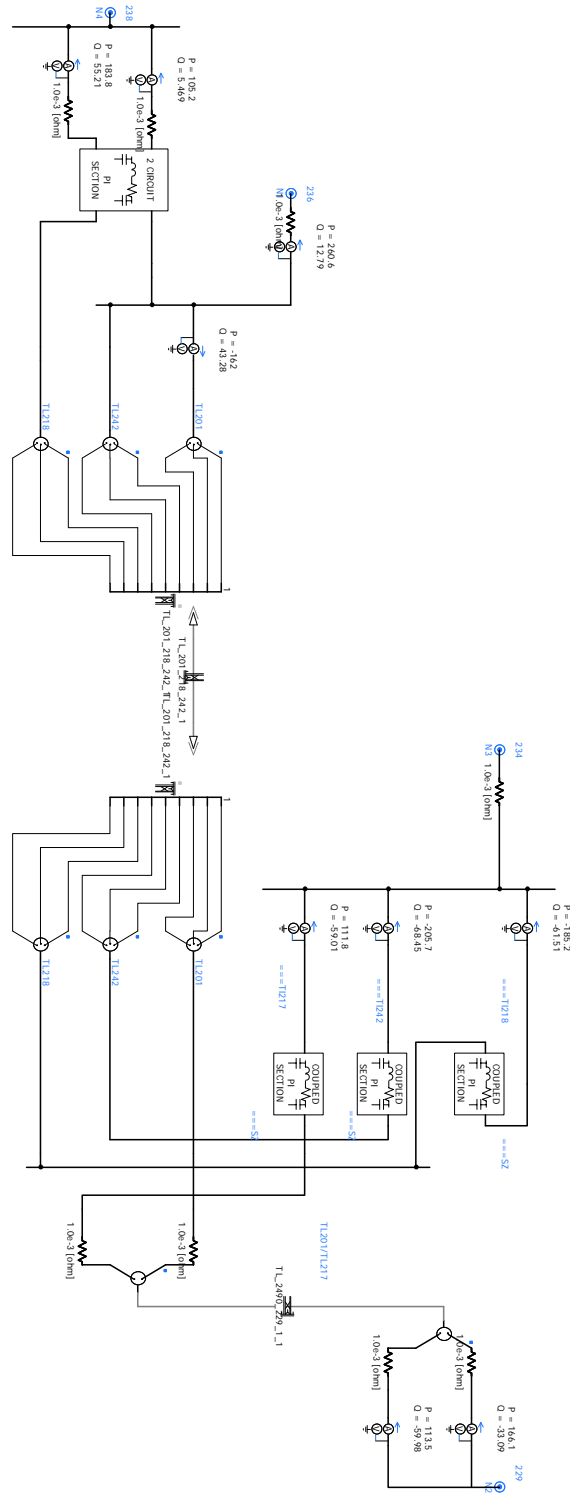

Figure 2-2 Example Line Layout

Frequency Dependent (Phase) Model Options

Travel Time Interpolation: On
 Curve Fitting Starting Frequency: 0.5 [Hz]
 Curve Fitting End Frequency: 1.0E6 [Hz]
 Total Number of Frequency Increments: 100
 Maximum Order of Fitting for Yc: 20
 Maximum Fitting Error for Yc: 1.0 [%]
 Max. Order per Delay Grp. for Prop. Func.: 20
 Maximum Fitting Error for Prop. Func.: 1.0 [%]
 DC Correction: Disabled
 Passivity Checking: Disabled

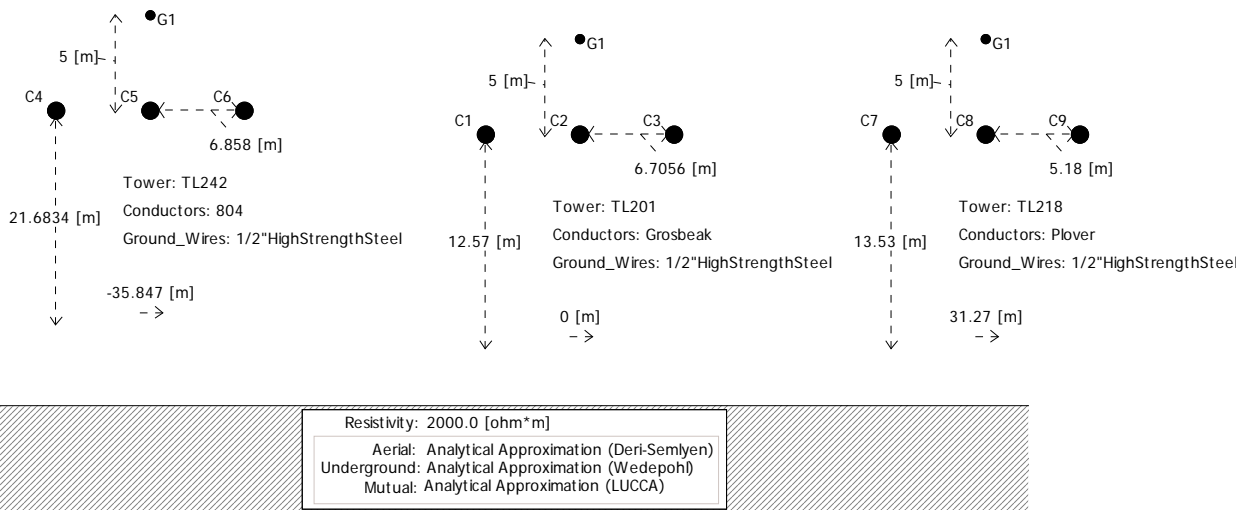

Figure 2-3 Detailed Line Model

2.3 Power Transformers

The power transformer models T5 at Sunny Side and T1 at Western Avalon are updated based on the following data files received from NLH:

- "WAVTS T5 nameplate.pdf"
- "WAVTS T5 Test Report.pdf"
- "Western Avalon-T5.pdf"
- "Sunnyside-T1.pdf"
- "SSDTS T1 Nameplate.pdf"
- "SSDTS T1 test report.pdf"

2.4 T5 Transformer at Sunny Side and T1 Transformer at Western Avalon

The T5 transformer at Sunnyside and the T1 transformer at Western Avalon is modeled based on the data provided by NLH. Figure 2-4 shows the PSCAD mode and Table 2-2 shows the data used to model the transformers.

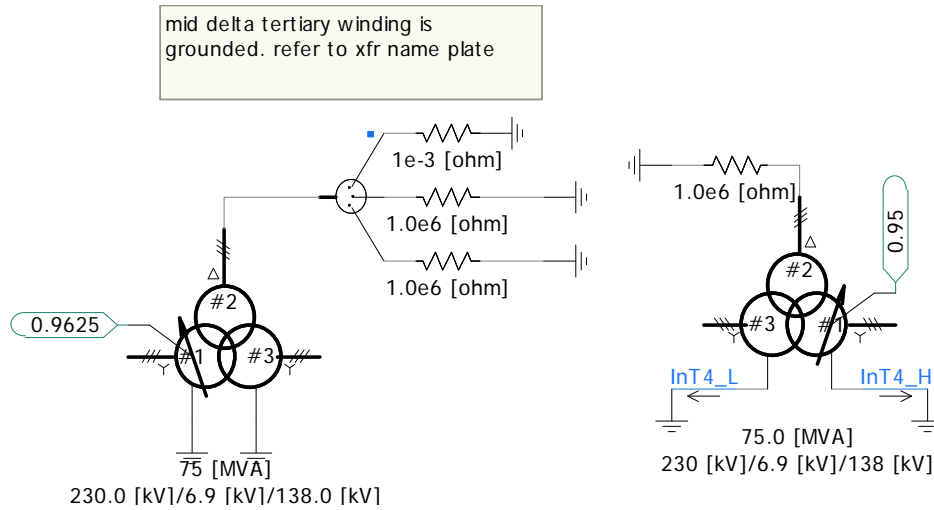

Figure 2-4 T1 - SSD T5 – WAV

Table 2-2 SSD T5 - WAV

| Name | Tmva | f | YD1 | YD2 | YD3 |
|------|-----------------|-----------------|--------------|----------------|----------|
| T5 | 75 [MVA] | 60.0 [Hz] | Y | Delta | Y |
| T1 | 75.0 [MVA] | 60.0 [Hz] | Y | Delta | Y |
| Name | Lead | XI12 | XI13 | XI23 | Ideal |
| T5 | Lags | 0.1796 [pu] | 0.0563 [pu] | 0.1347[pu] | Yes |
| T1 | Lags | 0.19677 [pu] | 0.05578 [pu] | 0.11371 [pu] | Yes |
| Name | NLL | CuL | Tap | V1 | V2 |
| T5 | 0.000533 [pu] | 0.00123335[pu] | #1 | 230.0 [kV] | 6.9 [kV] |
| T1 | 0.00057867 [pu] | 0.00149133 [pu] | #1 | 230 [kV] | 6.9 [kV] |
| Name | V3 | Enab | Sat | Hys | |
| T5 | 138.0 [kV] | Yes | Middle | Jiles_Atherton | |
| T1 | 138 [kV] | Yes | Middle | Jiles_Atherton | |

2.4.1.1 Sunny side Transformer Model Internal Fault Modeling

The T1 transformer model was modeled such that various internal faults can be applied to the transformer. Figure 2-5 shows the T1 transformer model that was used to investigate a failure of the a-phase winding to ground (short to the tank) and a failure between the windings. Figure 2-6 shows the SSD T1 parameters.

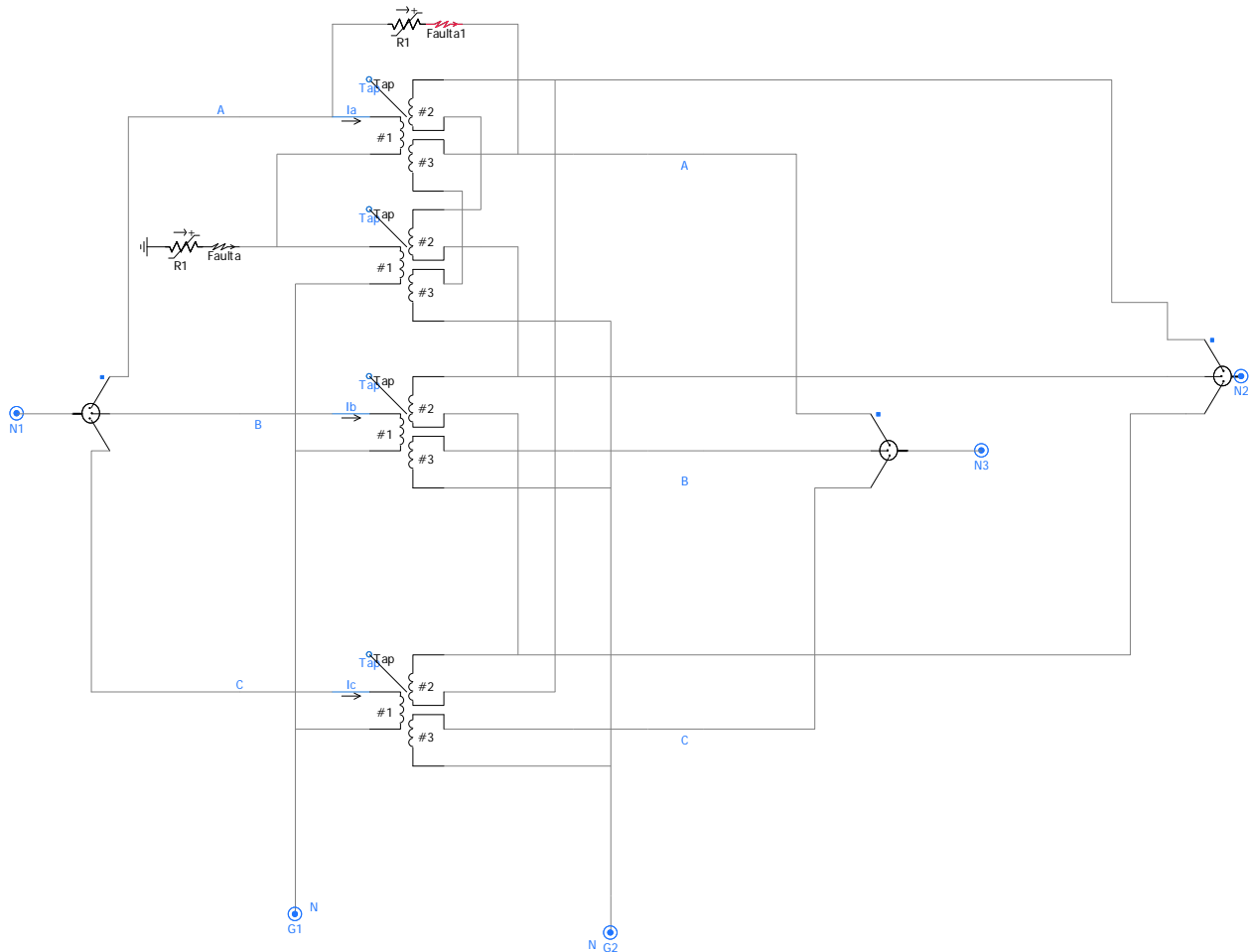

Figure 2-5 Sunny Side T1 Transformer Model

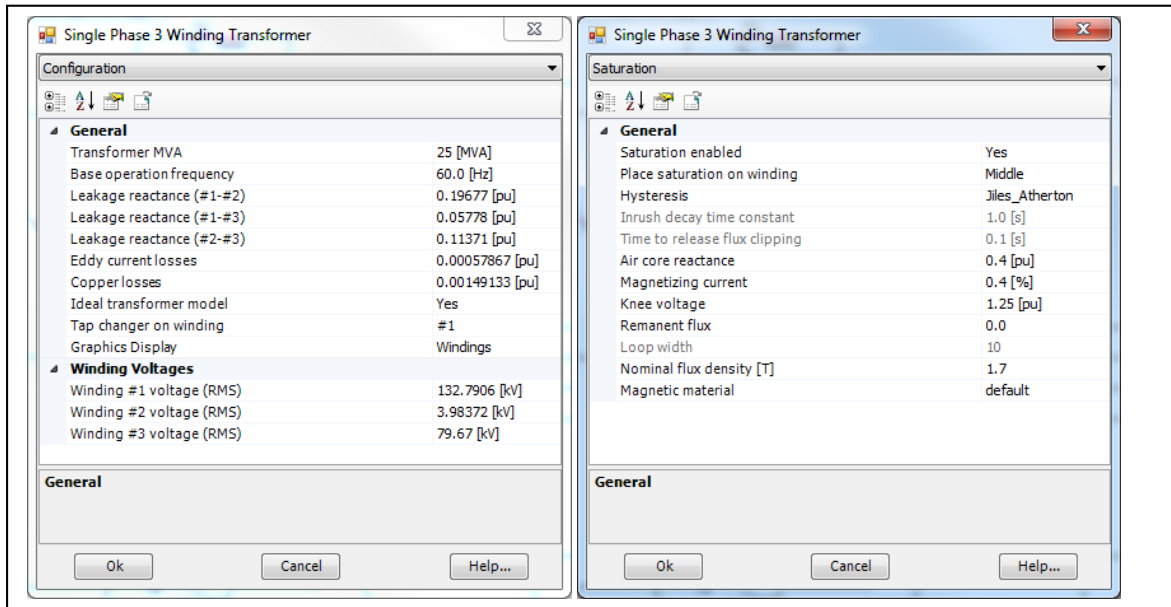

Figure 2-6 SSD T1 Parameters

2.5 PSCAD Model Benchmarking Against PSS/E

Upon development of the ac network in PSCAD based on the equivalent developed model in PSS/E, it is required to validate the PSCAD case against the equivalent case in PSSE. The validation was performed through comparison of the short circuit levels at certain buses and the results of the load flow and power transfer at some selected transmission lines.

The results of the comparison are shown in Table 2-3, Table 2-4 and Table 2-5. The results compare very well

Table 2-3 SCL Comparison

| Bus | Bus Number | SCL (MVA) | | % difference |
|----------------|------------|------------------|---------|--------------|
| | | PSS/E Equivalent | PSCAD | |
| Western Avalon | 195229 | 1997.30 | 1996.23 | 0.05 |
| Sunny side | 195222 | 2520.80 | 2469.65 | 2.03 |
| Bay D Espoir | 195221 | 2058.97 | 2014.47 | 2.16 |
| Hollyrood | 195234 | 2052.30 | 1998.49 | 2.62 |
| Stony Brook | 195216 | 3738.80 | 3601.09 | 3.68 |
| Oxen Pond | 195238 | 2164.00 | 2088.43 | 3.49 |

Table 2-4 Positive Sequence Impedance Comparison

| Bus | Bus Number | Positive Impedance magnitude Z+(Ohm) | | | Positive Impedance angle Z+(degree) | | |
|----------------|------------|---|-------|-----------------|--|-------|-----------------|
| | | PSS/E Equivalent | PSCAD | % difference | PSS/E Equivalent | PSCAD | % difference |
| Western Avalon | 195229 | 26.75 | 26.5 | 0.93 | 66.83 | 66.52 | 0.46 |
| Sunnyside | 195222 | 21.62 | 21.42 | 0.93 | 70.4 | 70.23 | 0.24 |
| Bay D Esprit | 195221 | 26.51 | 26.26 | 0.94 | 69.71 | 69.79 | -0.11 |
| Hollyrood | 195234 | 26.8 | 26.47 | 1.23 | 70.87 | 70.98 | -0.16 |
| Stony Brook | 195216 | 14.79 | 14.69 | 0.68 | 82.73 | 82.66 | 0.08 |
| Oxen Pond | 195238 | 25.39 | 25.33 | 0.24 | 78.77 | 78.68 | 0.11 |

Table 2-5 Loadflow Comparison

| From Bus Number | To Bus Number | Line | Real Power (MW) | | | Reactive Power (MVAR) | | |
|-----------------------|------------------|-------|---------------------|--------|-----------------|-----------------------|--------|-----------------|
| | | | PSS/E Equivalent | PSCAD | % difference | PSS/E Equivalent | PSCAD | % difference |
| 195229 | 195234 | TL217 | 109.5 | 113.1 | -3.29% | -60.5 | -59.72 | 1.29% |
| | 195236 | TL201 | 165.7 | 166.2 | -0.30% | -33.4 | -33.06 | 1.02% |
| | 195222 | TL203 | -213.8 | -216.3 | -1.17% | 56.8 | 56.1 | 1.23% |
| | 195227 | TL237 | -184.8 | 187.2 | -1.30% | 31 | 30.19 | 2.61% |
| 195222 | 195227 | TL207 | 214.1 | 217.1 | -1.40% | -110.2 | -109.3 | 0.82% |
| | 195221 | TL206 | -272.0 | -275.8 | -1.40% | 54.9 | 53.58 | 2.40% |
| | 195221 | TL202 | -273.3 | -275.8 | -0.91% | 56 | 53.59 | 4.30% |
| 195221 | 195216 | TL204 | 57.4 | 55.28 | 3.69% | -5.0 | -5.3 | -6.00% |
| | 195216 | TL231 | 57.6 | 55.28 | 4.03% | -5.0 | -5.3 | -6.00% |
| | 195220 | TL234 | -115 | -114.6 | 0.35% | -15.9 | -16.68 | -4.91% |

3. Modeling of Fault

The modeling of the fault sequence was based on the AMEC report “Newfoundland and Labrador Hydro Transmission Availability” March 21, 2014. The detailed sequence of events was given as shown Table 3-1 below:

Table 3-1 AC System Fault Sequence

| Time | delta-T | PSCAD Time | event | PSCAD Breaker Label |
|---|---------|------------|-----------------------------------|------------------------|
| 9:05:34.6 | | 3.1 | Fault | Please see section 3.1 |
| 9:05:34.715 | 0.115 | 3.215 | 138kV Breaker L109T4 at SSD Opens | CB1 |
| 9:05:34.753 | 0.038 | 3.253 | 138kV Breaker B3T4 at SSD Opens | CB11 |
| 9:05:34.755 | 0.002 | 3.255 | 230kV Breaker B1L02 at SSD Opens | CB2 |
| 9:05:34.786 | 0.031 | 3.286 | 138kV Breaker B2T1 at SSD Opens | CB3 |
| 4 of 5 breakers for T1 now open, B1L03 does not open | | | | |
| 9:05:36.719 | 1.933 | 5.219 | Breaker L03L06 at SSD opens | CB5 |
| | | 5.219 | Breaker B1B2 at CBC Opens | CB5 |
| 9:05:36.742 | 0.023 | 5.242 | Breaker L03L06 at SSD opens | CB6 |
| 9:05:36.820 | 0.078 | 5.32 | Breaker L03L17 at WAV opens | CB7 |
| 9:05:36.991 | 0.171 | 5.91 | Breaker L01L03 at WAV opens | CB8 |

3.1 Transformer Fault

In addition to the fault sequence modeled above, internal faults on the transformer were modeled. After various faults were applied, Table 3-2 shows the internal fault sequence that was found to give the closest results to the transformer fault.

Table 3-2 Internal Transformer Fault Sequence

| PSCAD Time | event |
|------------|---|
| 3.1 | Fault applied between phase A 230kV and 138 kV windings with a resistance of 50 ohms |
| 3.15 | Internal winding fault evolves into a 230kV to ground fault with a resistance of 50 ohms |
| 3.2 | Fault resistance decreases from 50 ohms to 25 ohms |
| 4.0 | A-phase to ground fault evolves to a 3-phase to ground fault with a resistance of 50 ohms |
| 4.2 | Resistance of 3-phase faults decreases from 50 ohms to 25 ohms |
| 4.7 | Resistance of 3-phase faults decreases from 50 ohms to 10 ohms |

4. Results

Appendix 2 shows the results for the fault. As it is unknown if this is the actual fault that was experienced by the transformer, comparing values would not be useful. Of more use is comparing the trend. What is obvious right away is that as breaker B1L03 did not open, the fault on the transformer was being sustained as shown in Figure 4-1. Referring to Figure 4-2, the neutral current in T1 extinguished before the breakers cleared the fault. Based on the simulations, it seems more likely that the CT or the cabling was damaged during the event which led to a loss of measurement.

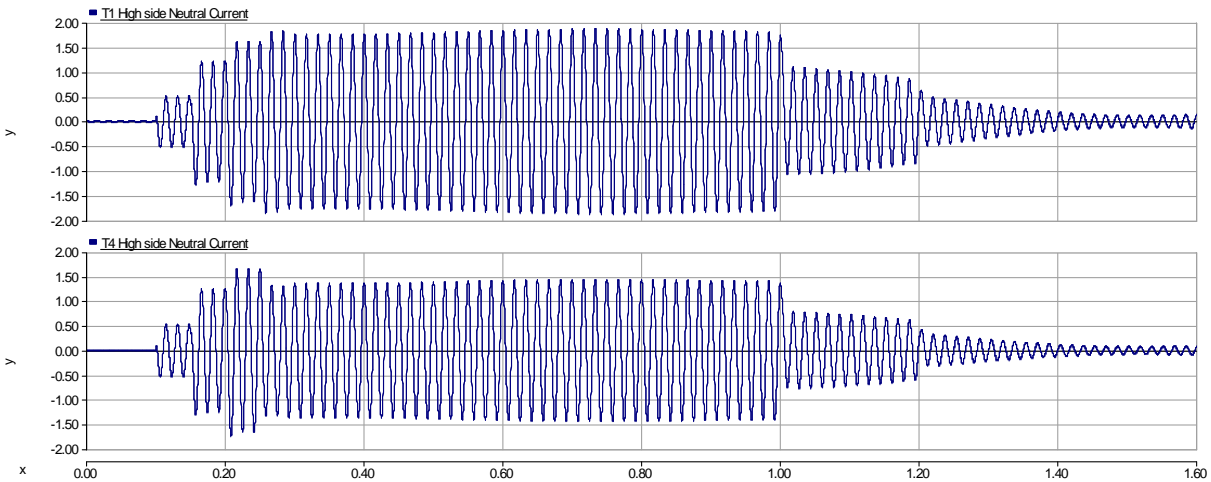

Figure 4-1 PSCAD Simulation

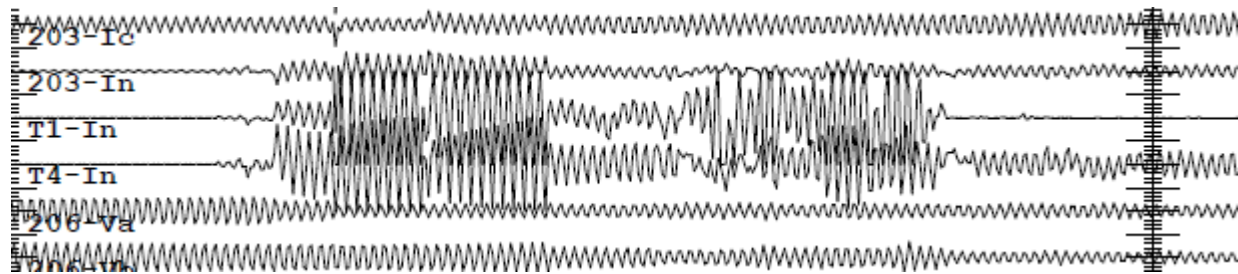

Figure 4-2 Actual Event

Figure 4-3 shows the currents in the actual windings of the failed transformer during the fault.

Figure 4-4 shows the harmonics spectrum in the transformer during the fault.

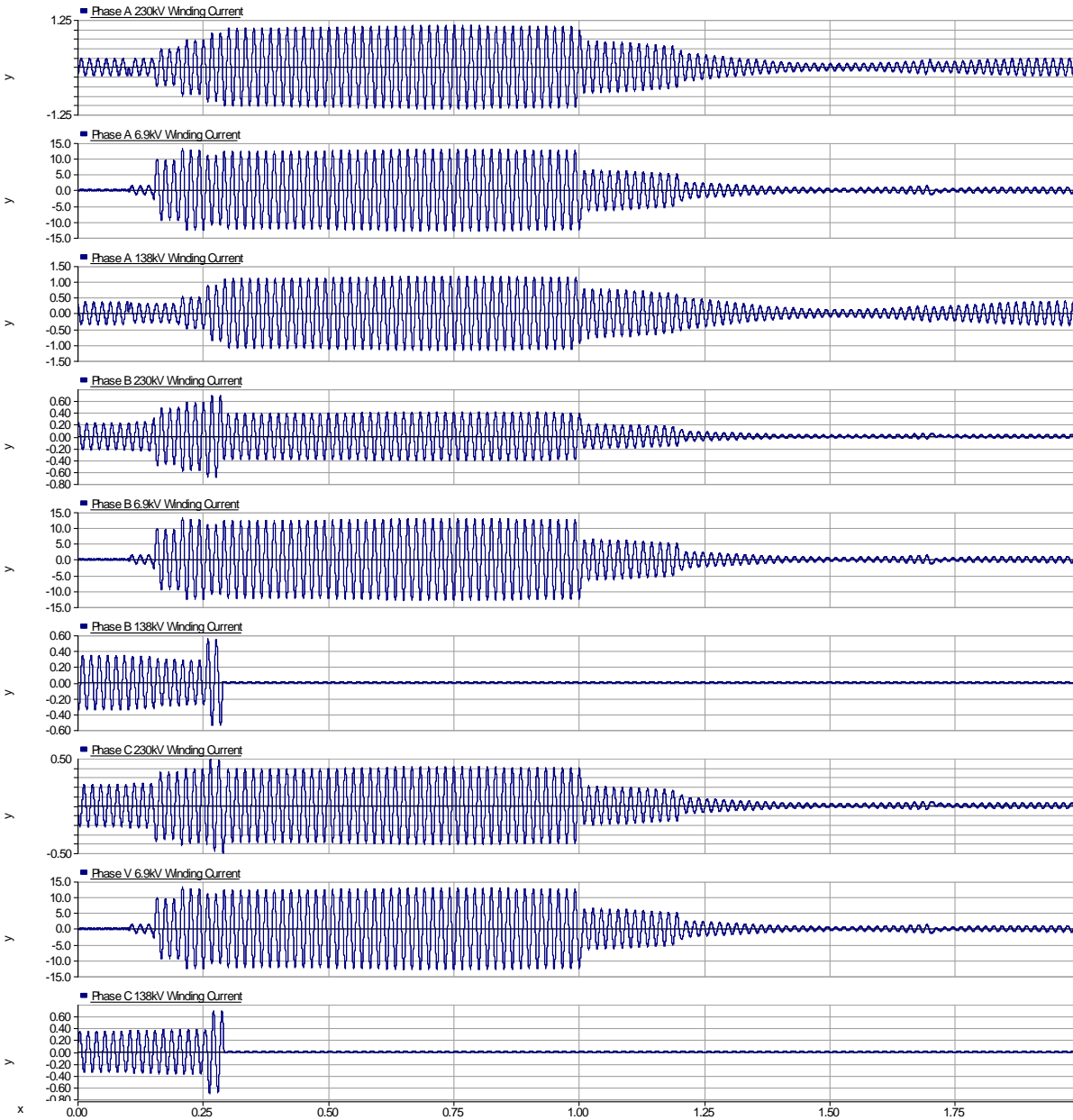

Figure 4-3 Transformer Currents

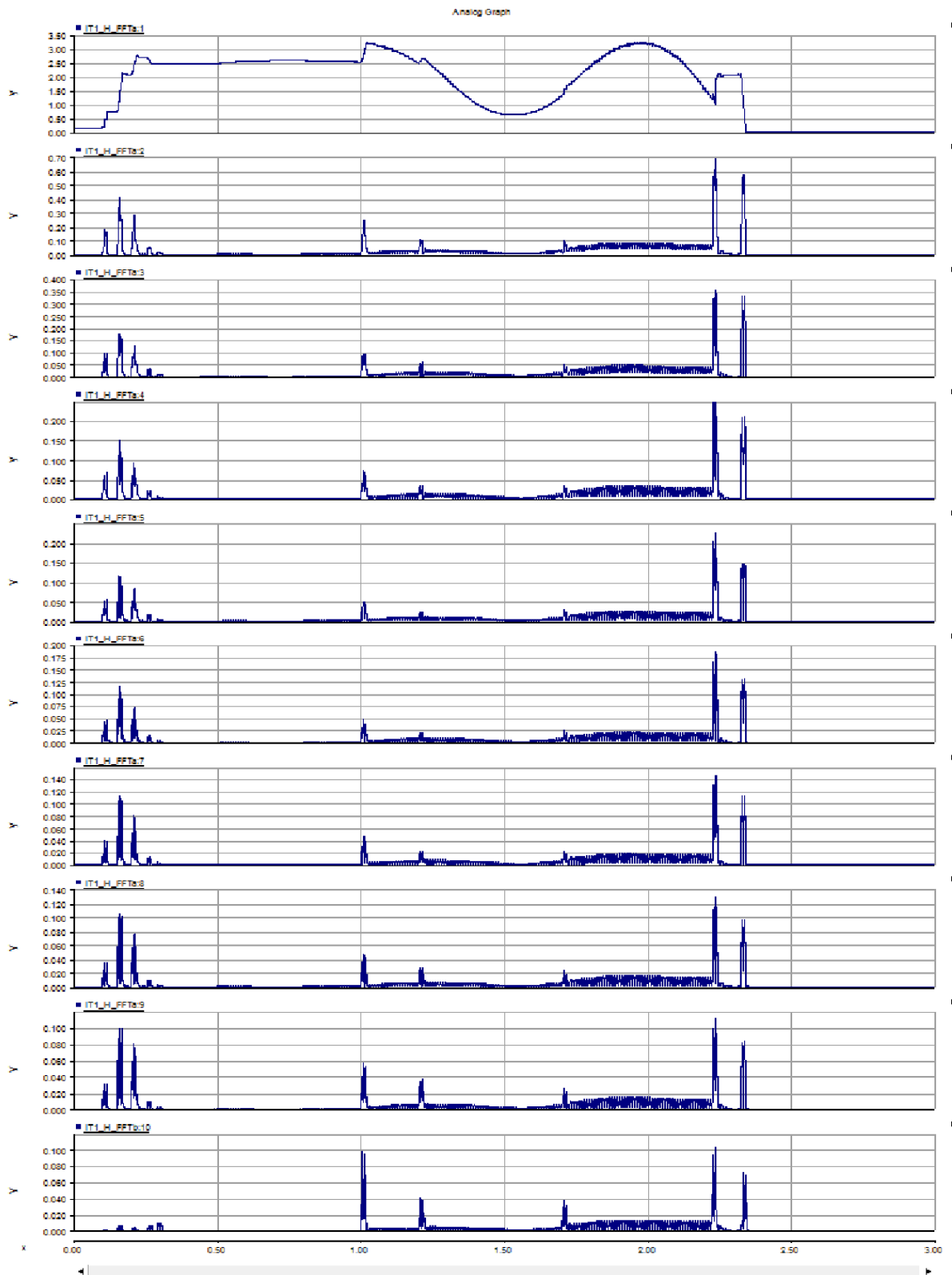

Figure 4-4 Harmonics of Transformer (RMS)

Figure 4-5 shows the P, Q and speed of the Bay D'Espoir unit 1 and the current in line TL237 and the Western Avalon bus voltage. As indicated in the AMEC report, and confirmed here, the ac system starts to go unstable for this fault.

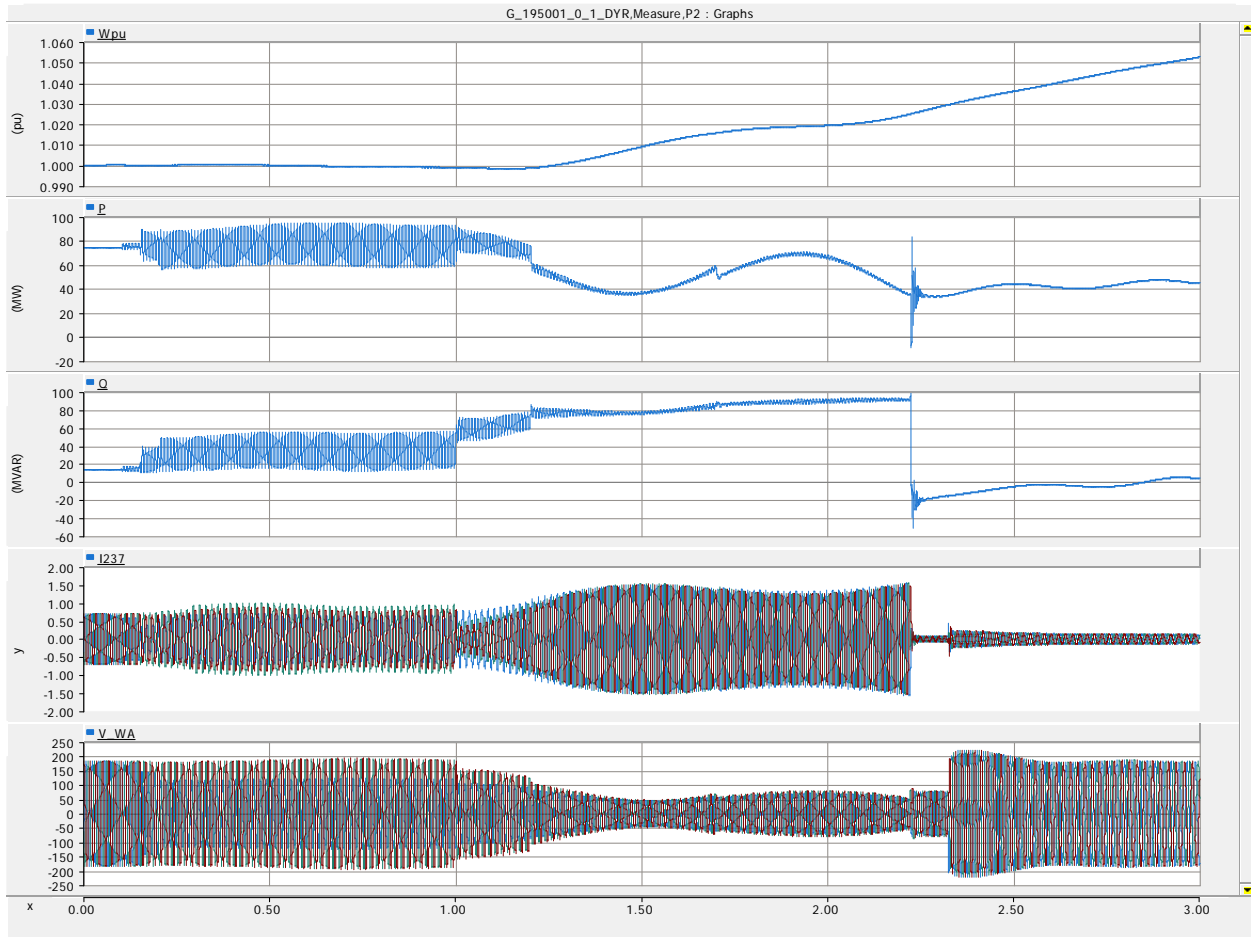

Figure 4-5 Bay D'Espoir and TL237 measurements

5. Conclusions and Recommendations

Although the exact fault has not been reproduced here, a fairly comparable one has been simulated. It is evident that due to the long duration it took to clear the transformer fault, the transformer experienced very high currents, with nearly 2.5kA flowing for the duration of the fault.

TGS recommends that once more details are available about the actual fault of the transformer, that the model be updated and simulations rerun to recreate what happened. This new information will give further confidence in the developed model and allow for future studies to be done either as a system strengthening exercise or for a post-mortem on future faults.

6. Appendix 1 – Actual TFR Traces

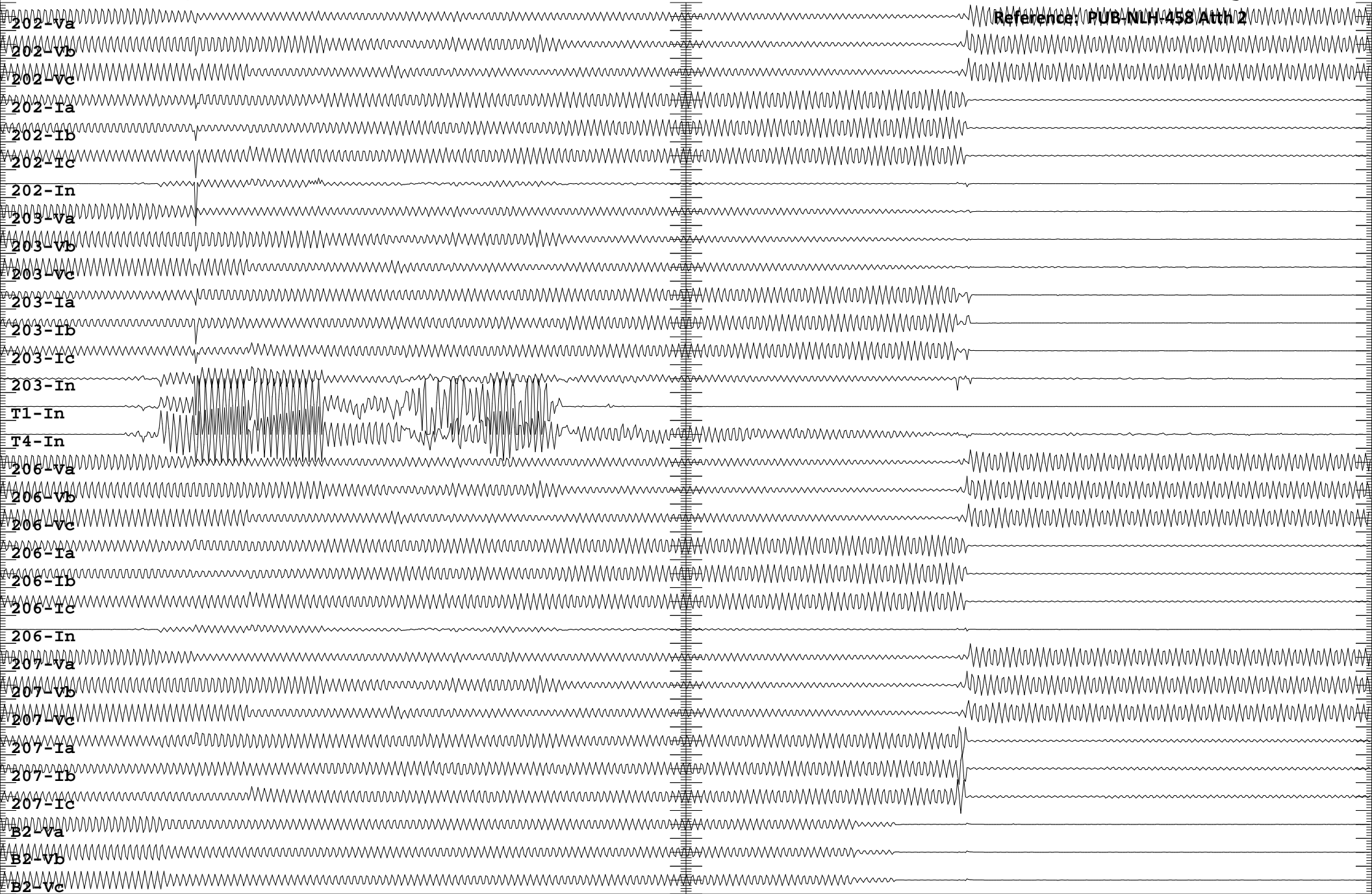

Reference: PUB-NLH-458/Att1/2

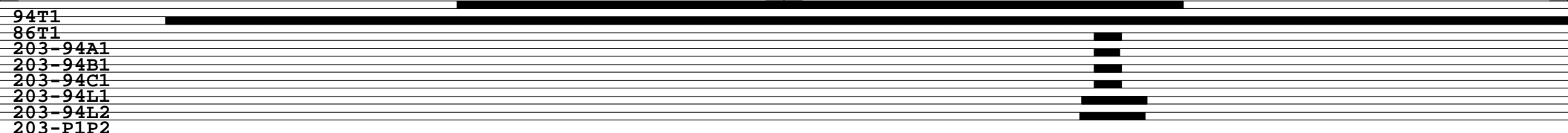

0.000 ms

1791.667 ms

| Trace | Label | Name | Scale | Units/Division |
|-------|----------|------------------------------|-------|----------------|
| 1 | 202-Va | 230 KV TL202 A Phase Voltage | 1.00 | 72177.652 V |
| 2 | 202-Vb | 230 KV TL202 B Phase Voltage | 1.00 | 72458.470 V |
| 3 | 202-Vc | 230 KV TL202 C Phase Voltage | 1.00 | 72601.507 V |
| 4 | 202-Ia | TL202 A Phase Current | 5.00 | 338.114 A |
| 5 | 202-Ib | TL202 B Phase Current | 5.00 | 338.290 A |
| 6 | 202-Ic | TL202 C Phase Current | 5.00 | 339.371 A |
| 7 | 202-In | TL202 Neutral Current | 15.00 | 113.019 A |
| 8 | 203-Va | 230 KV TL203 A Phase Voltage | 1.00 | 72423.934 V |
| 9 | 203-Vb | 230 KV TL203 B Phase Voltage | 1.00 | 72506.562 V |
| 10 | 203-Vc | 230 KV TL203 C Phase Voltage | 1.00 | 72394.188 V |
| 11 | 203-Ia | TL203 A Phase Current | 5.00 | 337.960 A |
| 12 | 203-Ib | TL203 B Phase Current | 5.00 | 338.712 A |
| 13 | 203-Ic | TL203 C Phase Current | 5.00 | 338.641 A |
| 14 | 203-In | TL203 Neutral Current | 15.00 | 112.692 A |
| 15 | T1-In | T1 Neutral Current | 2.00 | 1059.220 A |
| 16 | T4-In | T4 Neutral Current | 2.00 | 1059.457 A |
| 17 | 206-Va | 230KV TL206 A Phase Voltage | 1.00 | 72296.314 V |
| 18 | 206-Vb | 230KV TL206 B Phase Voltage | 1.00 | 72600.926 V |
| 19 | 206-Vc | 230KV TL206 C Phase Voltage | 1.00 | 72753.172 V |
| 20 | 206-Ia | TL206 A Phase Current | 5.00 | 339.398 A |
| 21 | 206-Ib | TL206 B Phase Current | 5.00 | 338.909 A |
| 22 | 206-Ic | TL206 C Phase Current | 5.00 | 338.978 A |
| 23 | 206-In | TL206 Neutral Current | 15.00 | 113.283 A |
| 24 | 207-Va | 230KV TL207 A Phase Voltage | 1.00 | 72562.495 V |
| 25 | 207-Vb | 230KV TL207 B Phase Voltage | 1.00 | 72516.289 V |
| 26 | 207-Vc | 230KV TL207 C Phase Voltage | 1.00 | 72466.927 V |
| 27 | 207-Ia | TL207 A Phase Current | 5.00 | 339.563 A |
| 28 | 207-Ib | TL207 B Phase Current | 5.00 | 338.912 A |
| 29 | 207-Ic | TL207 C Phase Current | 5.00 | 340.012 A |
| 30 | B2-Va | 138 KV B2 A Phase Voltage | 1.00 | 43573.561 V |
| 31 | B2-Vb | 138 KV B2 B Phase Voltage | 1.00 | 43518.666 V |
| 32 | B2-Vc | 138 KV B2 C Phase Voltage | 1.00 | 43444.008 V |
| 33 | 94T1 | 94T1 | N/A | N/A |
| 34 | 86T1 | 86T1(NC) | N/A | N/A |
| 35 | 203-94A1 | TL203 94A1X | N/A | N/A |
| 36 | 203-94B1 | TL203 94B1X | N/A | N/A |
| 37 | 203-94C1 | TL203 94C1X | N/A | N/A |
| 38 | 203-94L1 | TL203 94L1 | N/A | N/A |
| 39 | 203-94L2 | TL203 94L2 | N/A | N/A |
| 40 | 203-P1P2 | TL203 21P1/P2 | N/A | N/A |

7. Appendix 2 – Simulated Traces

Reference: PUB-NIH-458/Att 2

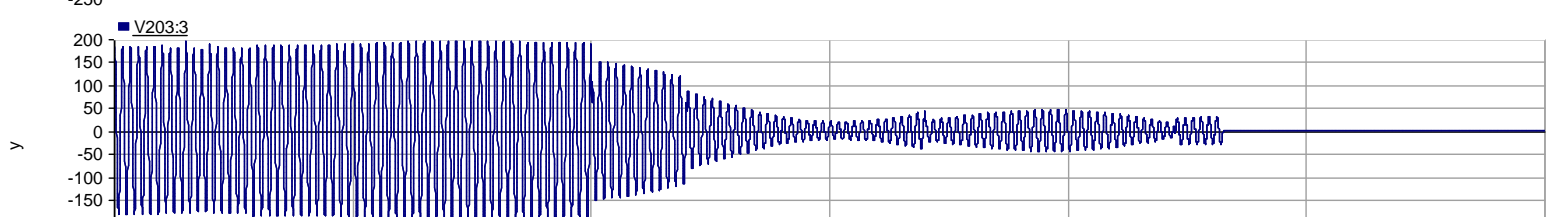
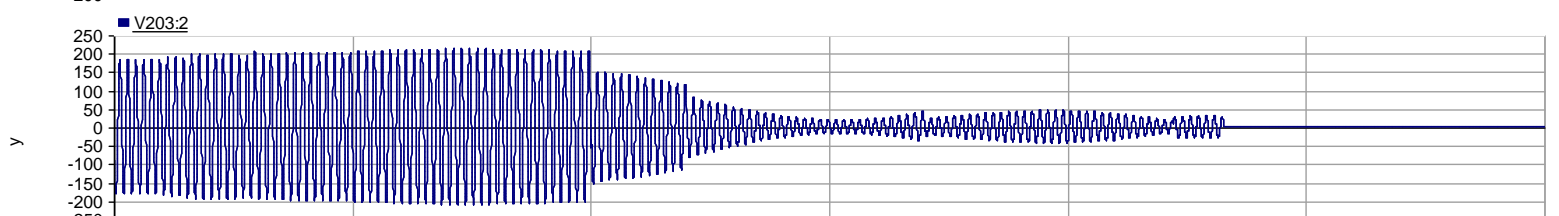
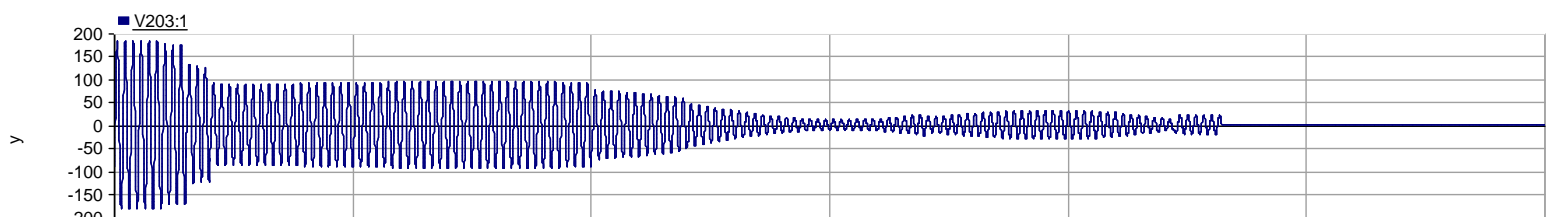
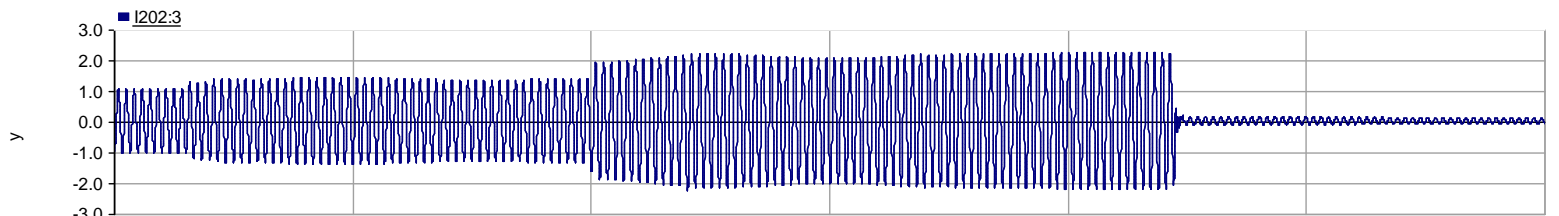
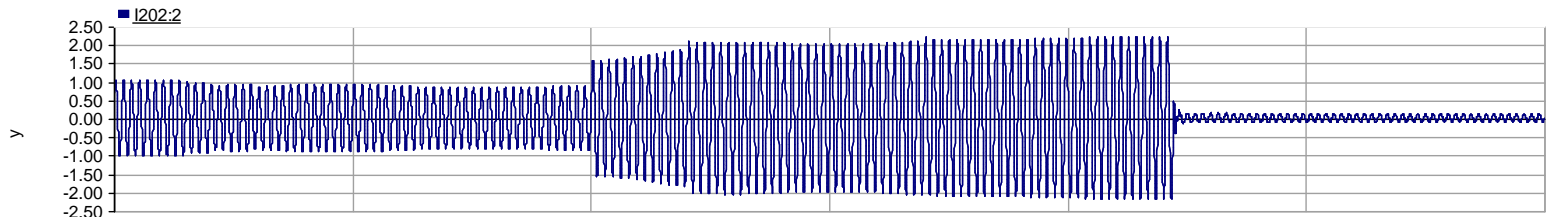
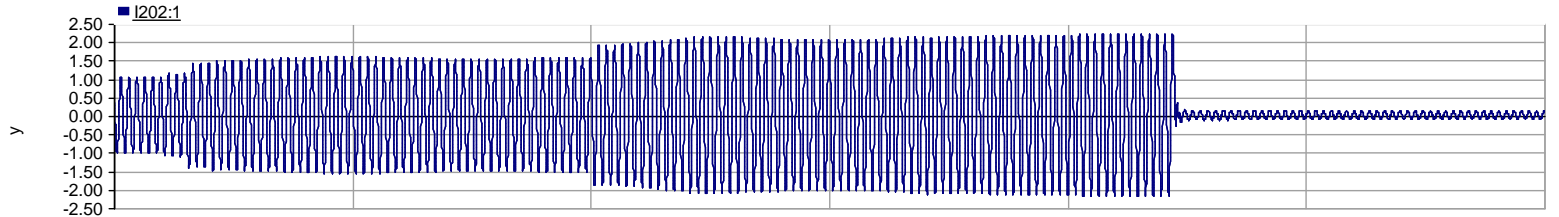
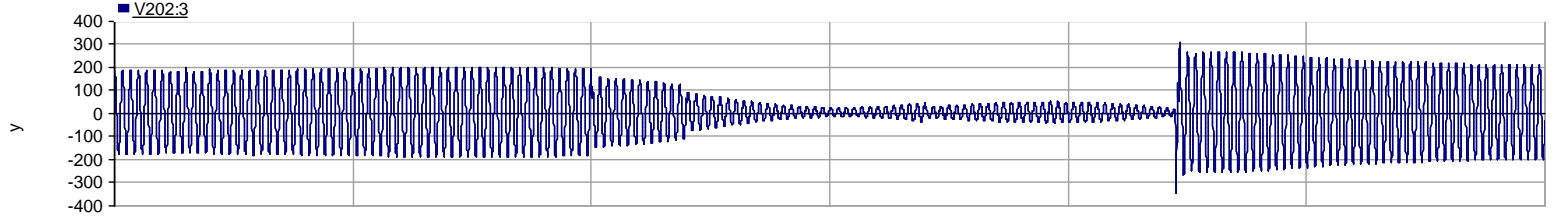
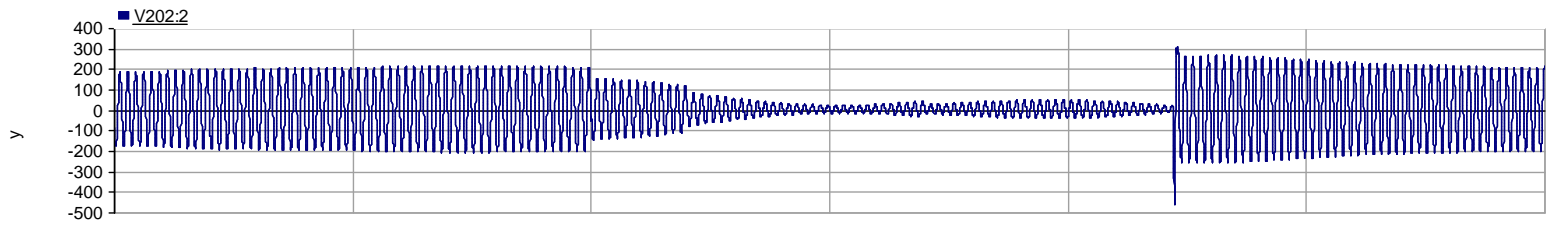
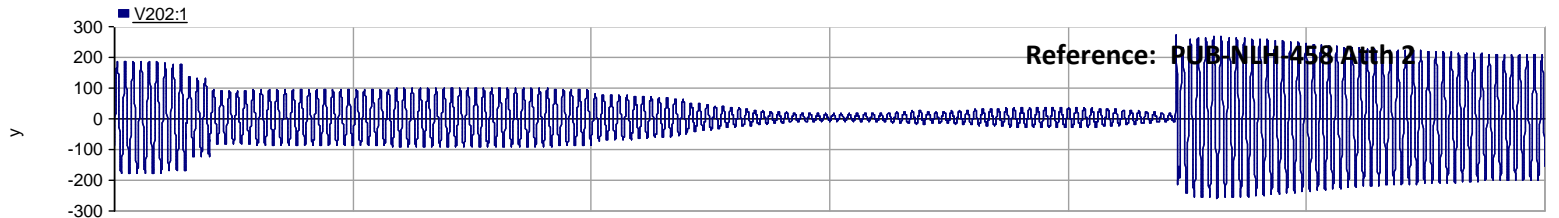

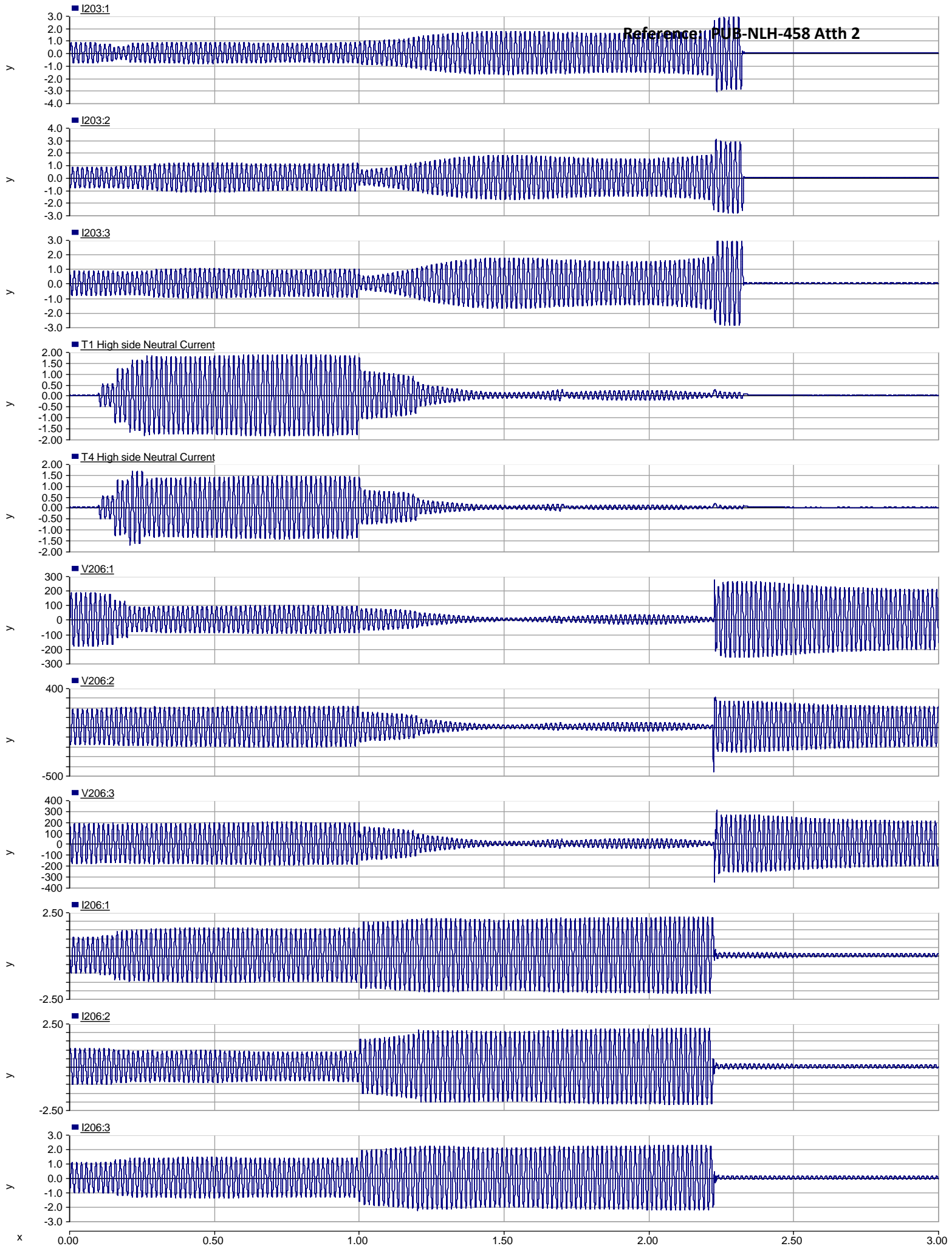

Reference: PUB-NIH-458/Att 2

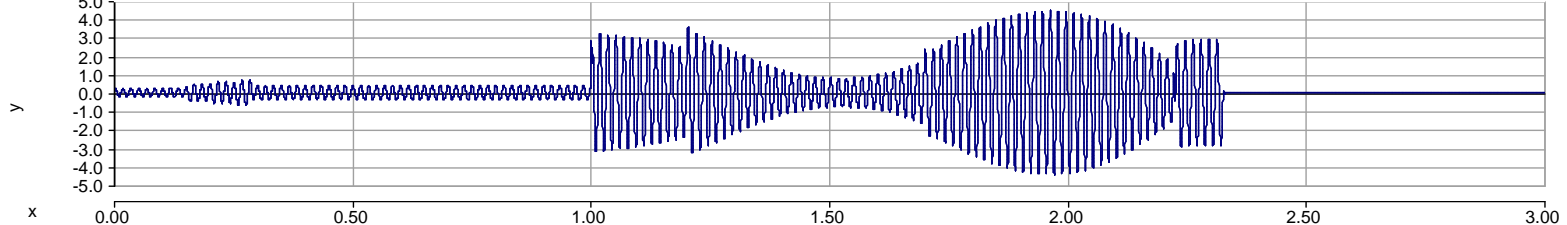
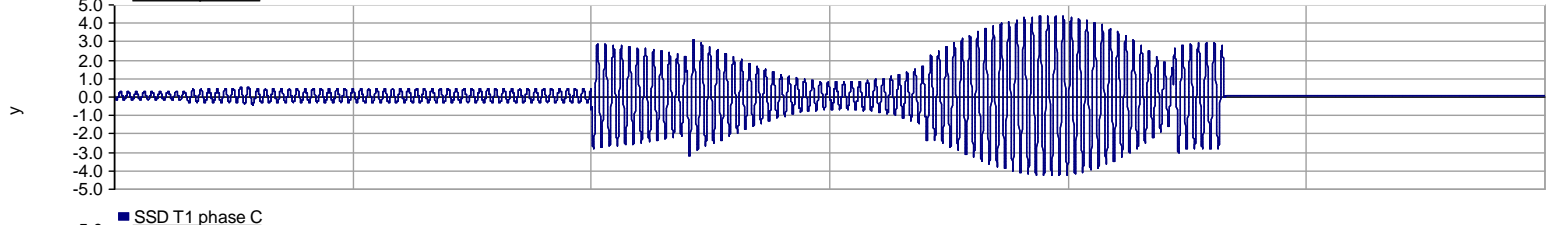
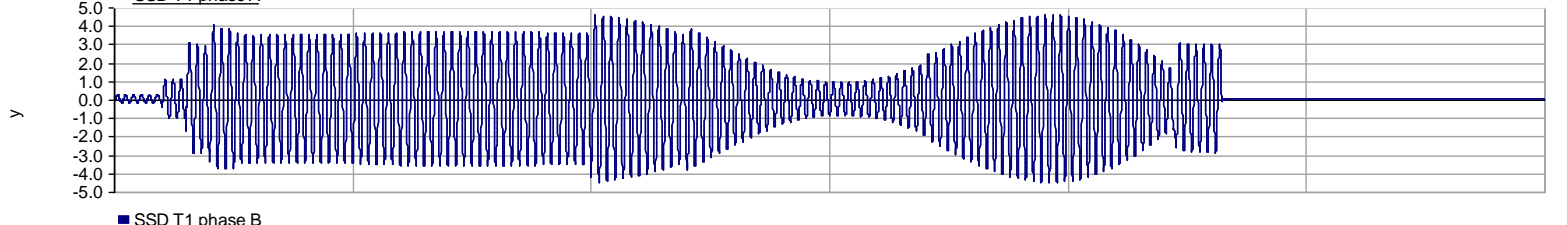
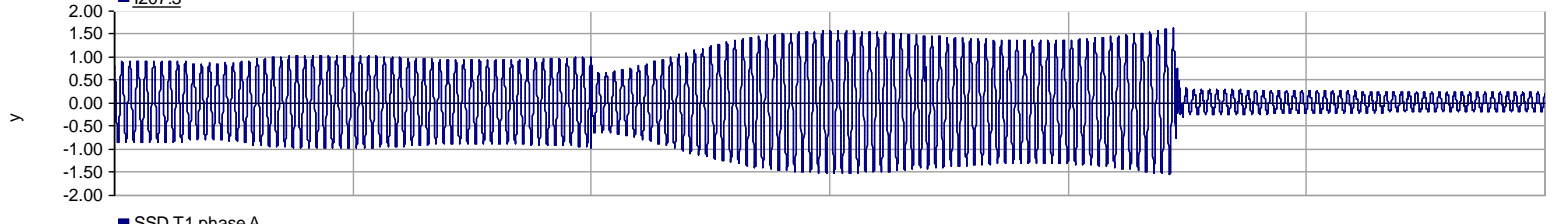
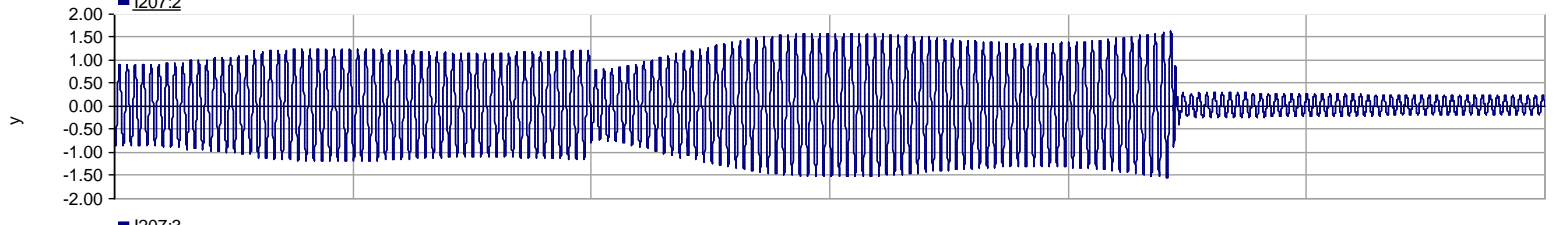
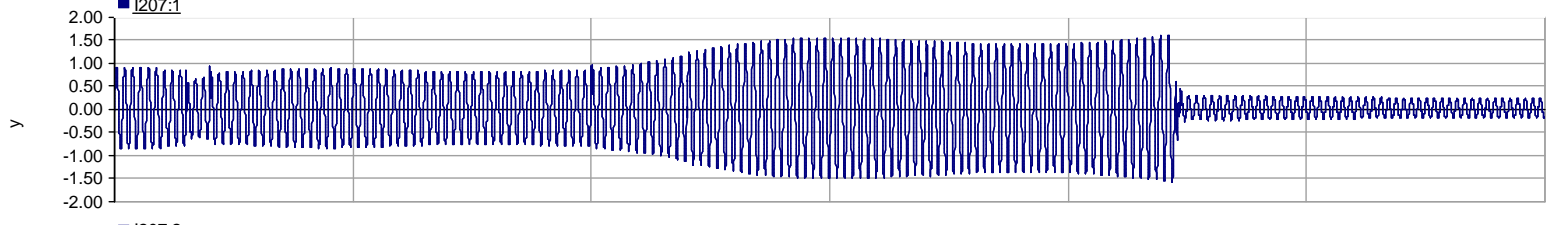
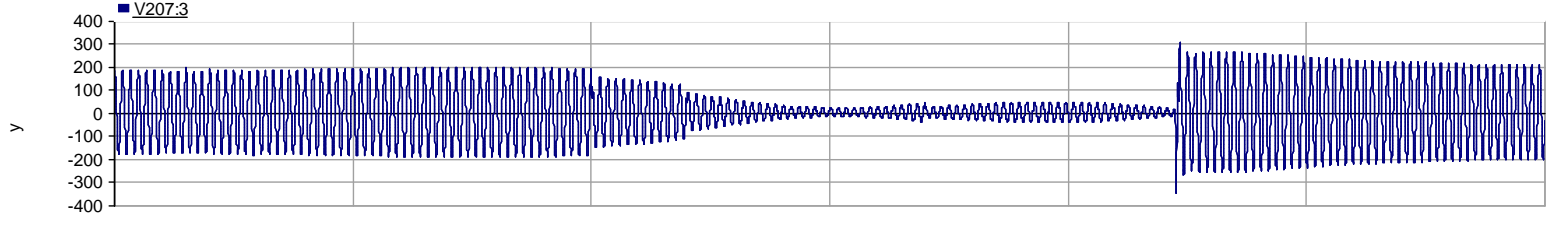
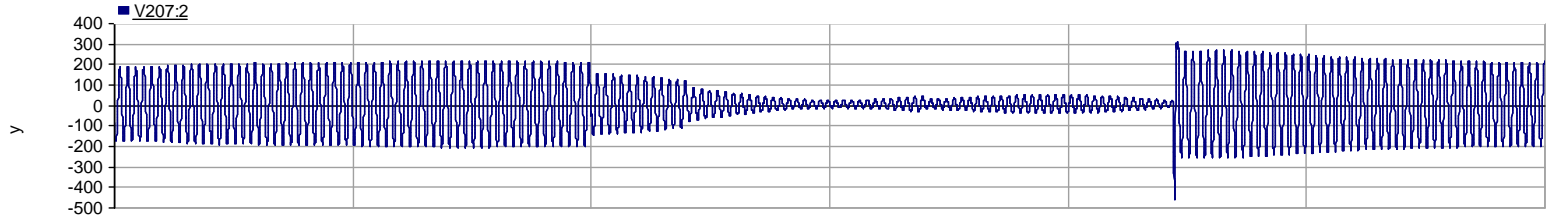
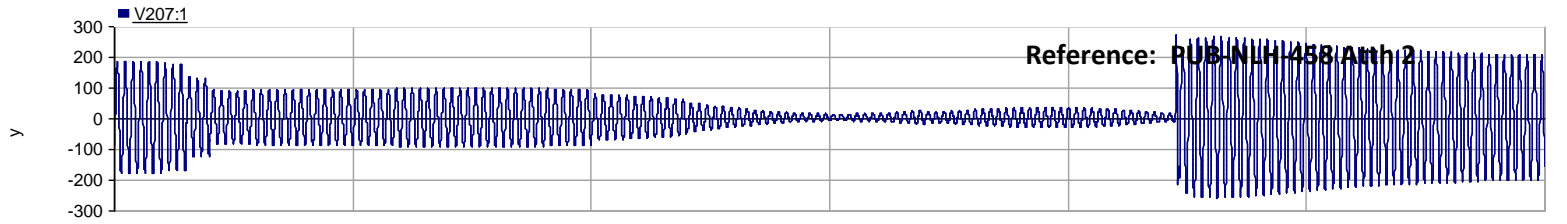

x

0.00 0.50 1.00 1.50 2.00 2.50 3.00

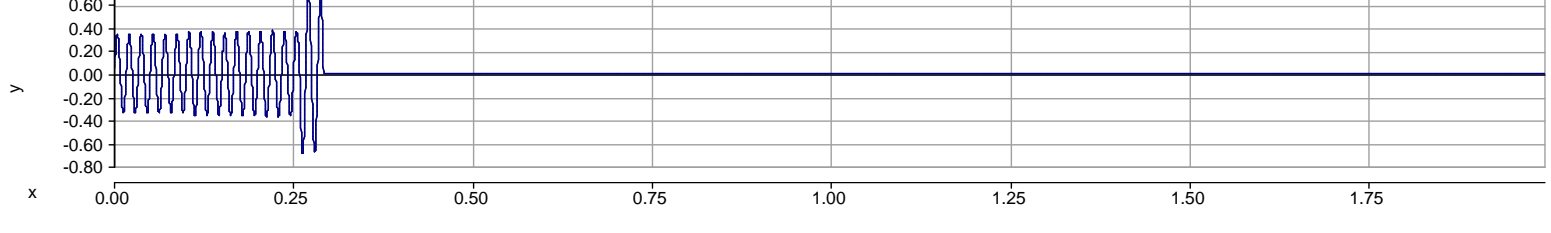
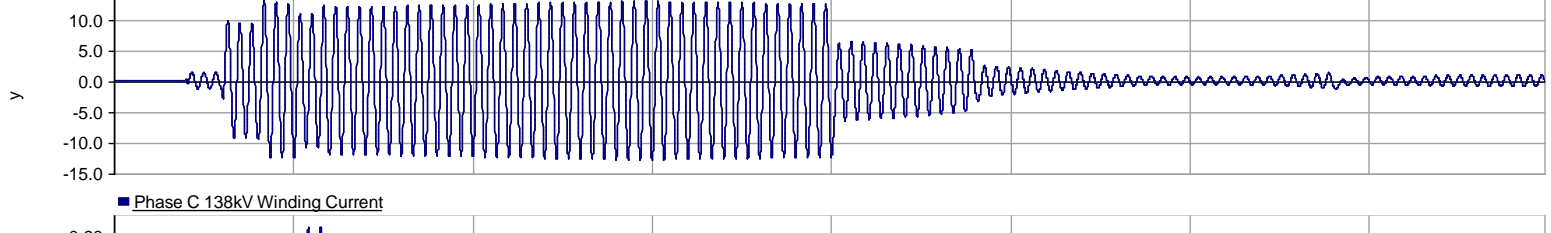
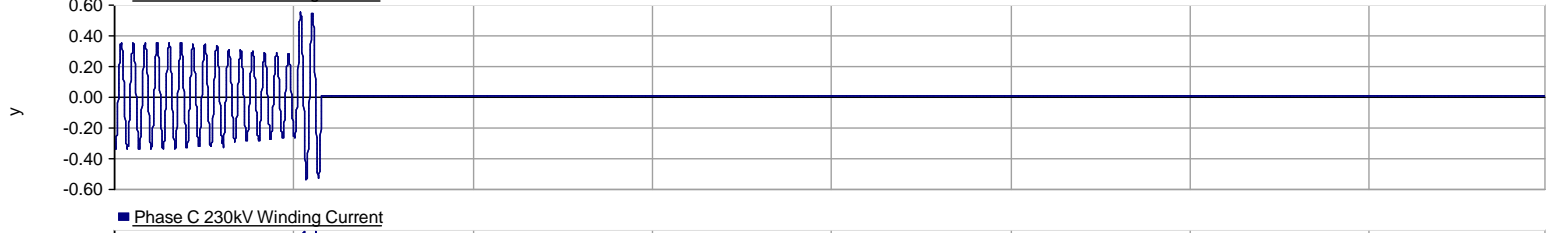
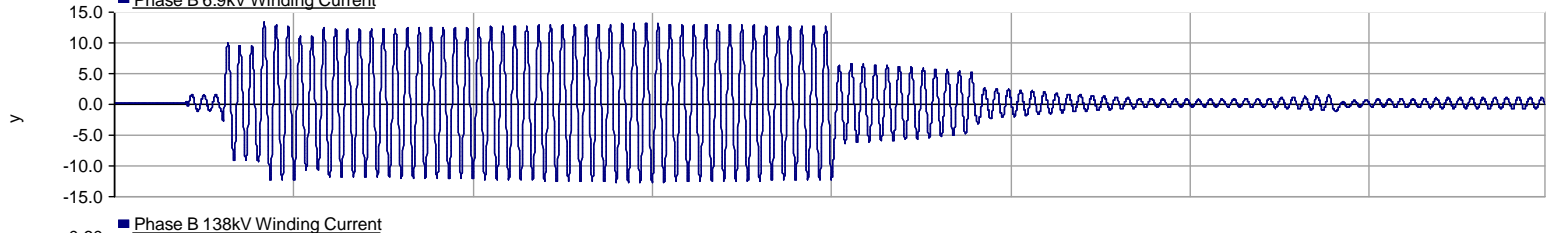
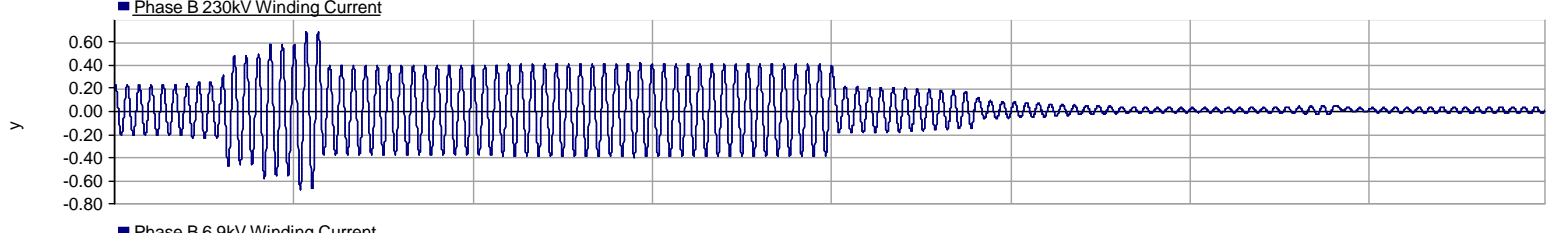
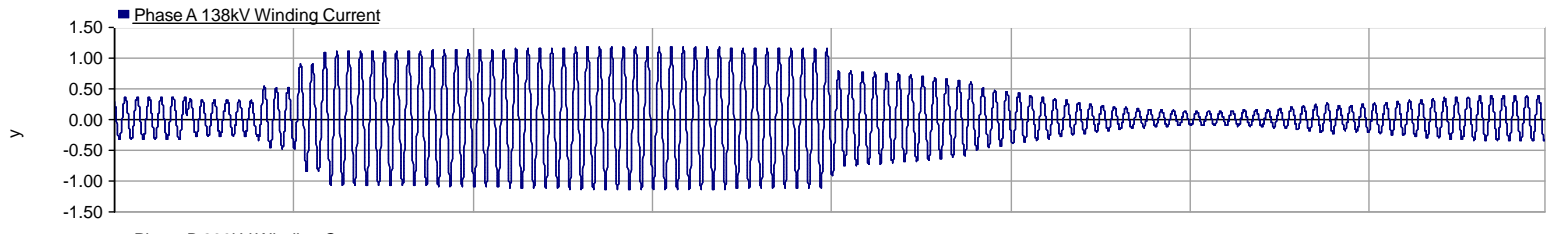
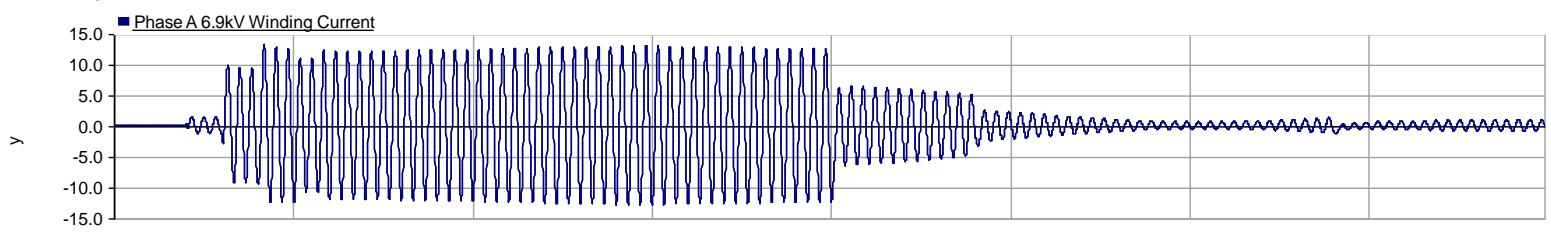
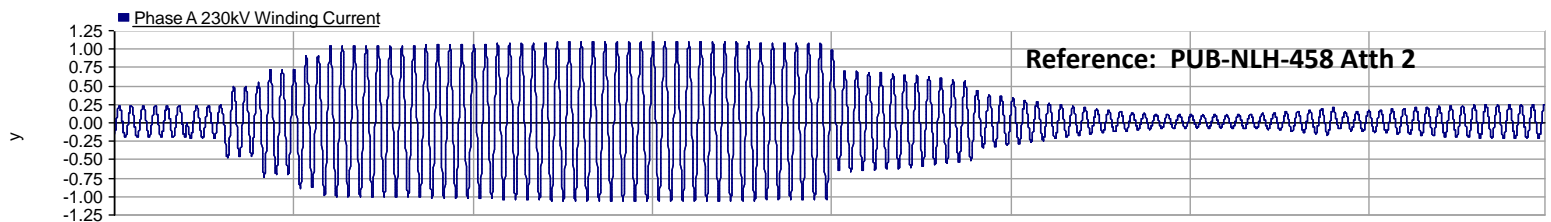

Reference: PUB-NLH-458 Atth 2

